

New



Skylights

Introducing
Commercial
SUN TUNNEL™ skylights
Capturing daylight for the workplace



Take it from the top... VELUX SunCurve



This highly transmissive light capturing VELUX SunCurve comes standard on every 22" commercial SUN TUNNEL™ skylight.

- Designed to capture sunrays that would normally pass through the dome, and instead directs them down the tunnel.



22" kit includes outer dome and VELUX SunCurve

What makes the VELUX SunCurve better?

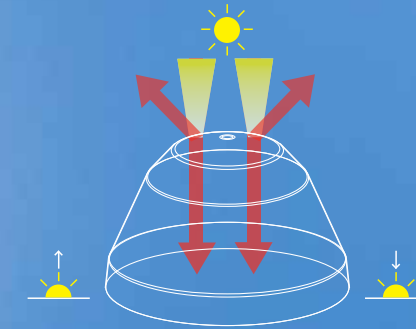

Mid-Day

Manage the intense, direct mid-day sun so that the space below is bright and comfortable without glare.

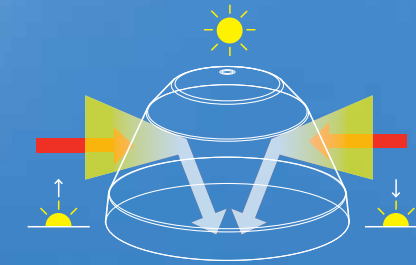

Morning and afternoon light

Captures low-angle sunlight and curves it down the tunnel.

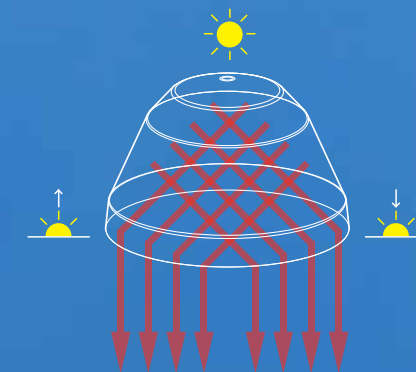

Consistent light levels

Evenly distribute sunlight for bright and comfortable light levels in the space below.

Choose the right flashing type for your installation:

Flat roof applications:



Self



Curb

Pitched roof applications:



Pitched
(14" only)

Flat roof applications:



Self



Curb

Roof-level accessories that increase performance:



Turret extender
(ZTA)



Exterior fire band
(ZZZ 192)



Thermal break
Energy upgrade kit
(ZTC)



Diffusion enhancer
(ZTC 209)



Maximum security kit
(ZTQ) - includes security
bars, tamper resistant
dome and curb fasteners.

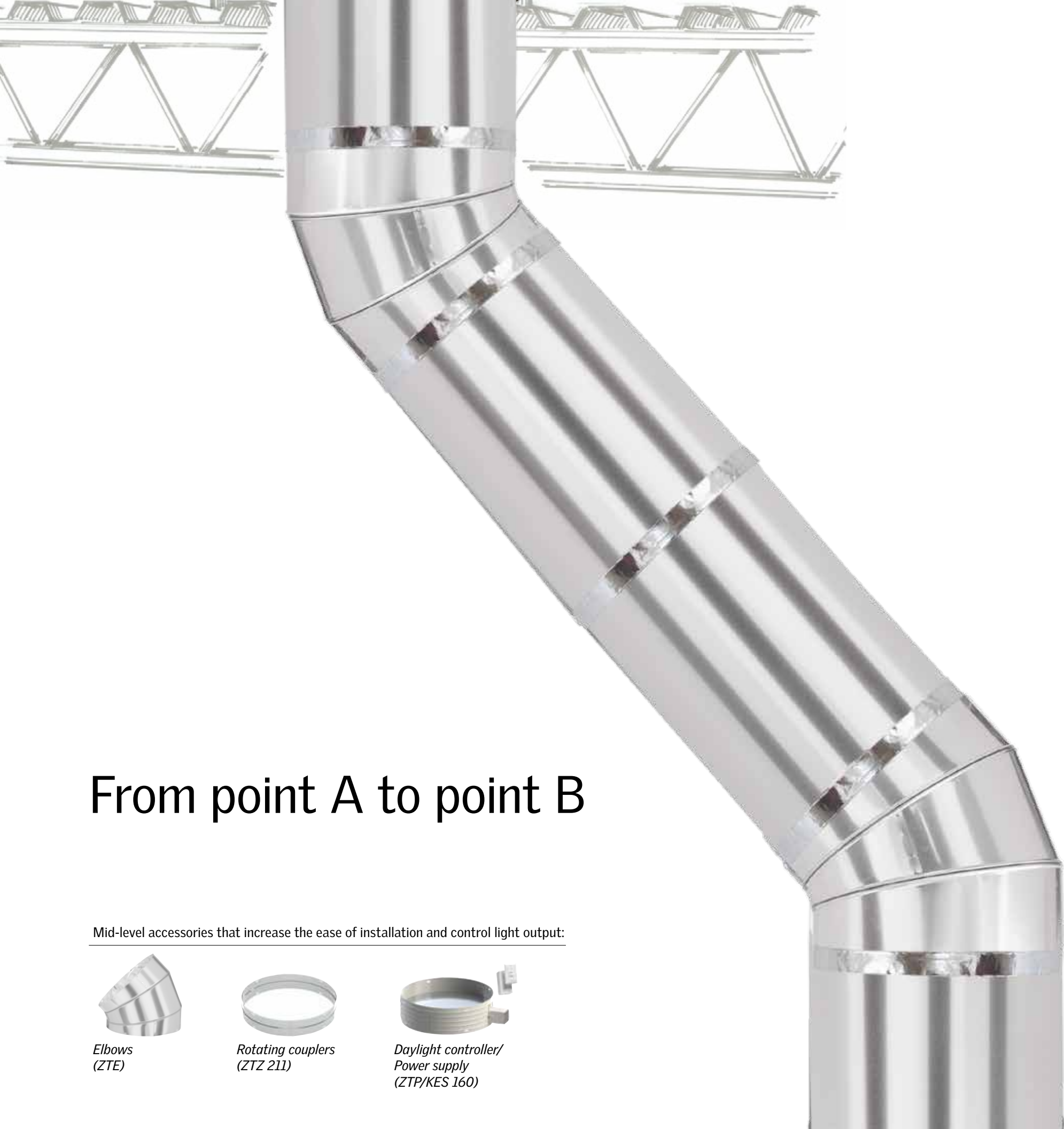

From point A to point B

Mid-level accessories that increase the ease of installation and control light output:



*Elbows
(ZTE)*



*Rotating couplers
(ZTZ 211)*



*Daylight controller/
Power supply
(ZTP/KES 160)*

Flexi Loc™ quick assembly system

A tunnel connection system that reduces tunnel installation time in half. With our unique Flexi Loc™ system, screws are a thing of the past. Use this unique clip system to piece your elbows, tunnel sections and other rigid tunnel components together quicker.



Highly reflective silver tunnel

**20-year
rigid tunnel
reflective
warranty**

All VELUX SUN TUNNEL skylights feature a highly reflective silver layer that is electrostatically applied.

- Creates an ultra smooth highly, reflective surface
- Greater than 98% total reflectivity (99.9% on silver layer)

The finishing touch

Choose from a variety of ceiling options to meet all of your application needs.
Available in 14" and 22"



Hard ceiling

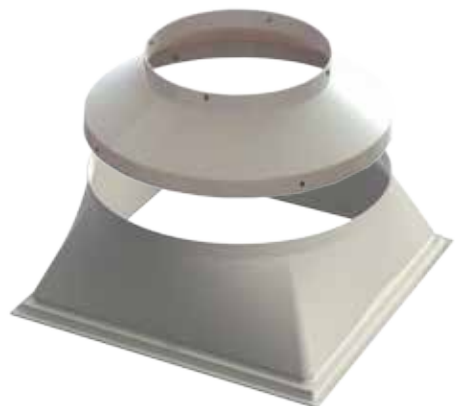

Suspended ceiling



Open ceiling (shown)



Diffuser options



Frosted diffuser
Frosted diffusers offer a combination of performance and aesthetics.



Prismatic diffuser
The industry standard prismatic diffusers provide good light distribution with the look and feel to match existing architectural design.



Fresnel diffuser
Fresnel diffusers utilize a concentric honeycomb pattern of parabolic prisms to maximize light diffusion.

Two ways to order

Option 1: Time-saving and easy-to-order configurable kits

- Designed to accommodate most applications
- Please call 1-800-888-3589 for customized configurations

Box 1: Choose your size and flashing type

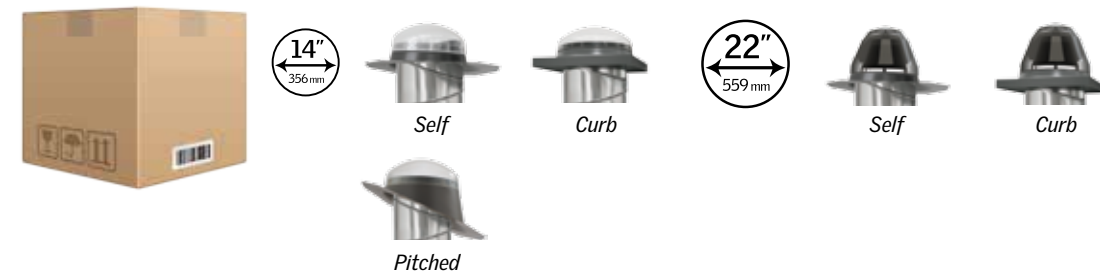

Box 2: Tunnel kit

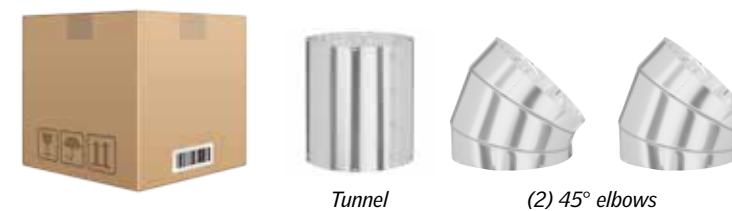

Box 3: Choose your diffuser type and diffuser material

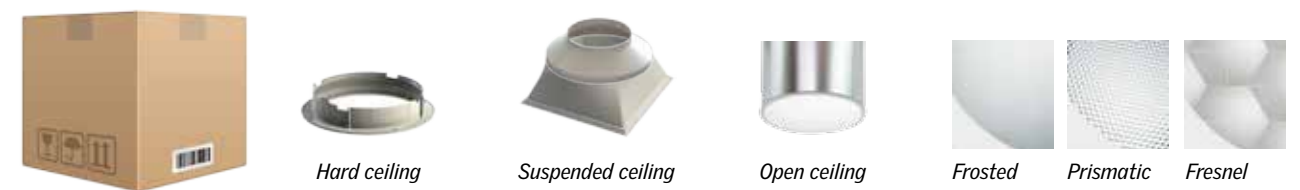

Please see price list for other accessories to help customize your commercial SUN TUNNEL skylight needs.



New **Option 2: Bulk purchasing program for SUN TUNNEL™ skylights is available**

- Please call 1-800-888-3589 for pricing and product availability
- Purchase VELUX SUN TUNNEL components in bulk quantities for additional savings

VELUX America Inc.
450 Old Brickyard Road
PO Box 5001
Greenwood, SC 29648-5001
Tel 1-800-888-3589
Fax 1-864-943-2631
veluxusa.com



www.facebook.com/veluxamerica
www.twitter.com/veluxamerica
www.youtube.com/veluxusa

Bringing light to life™

VELUX®